

World leaders in dehumidification.

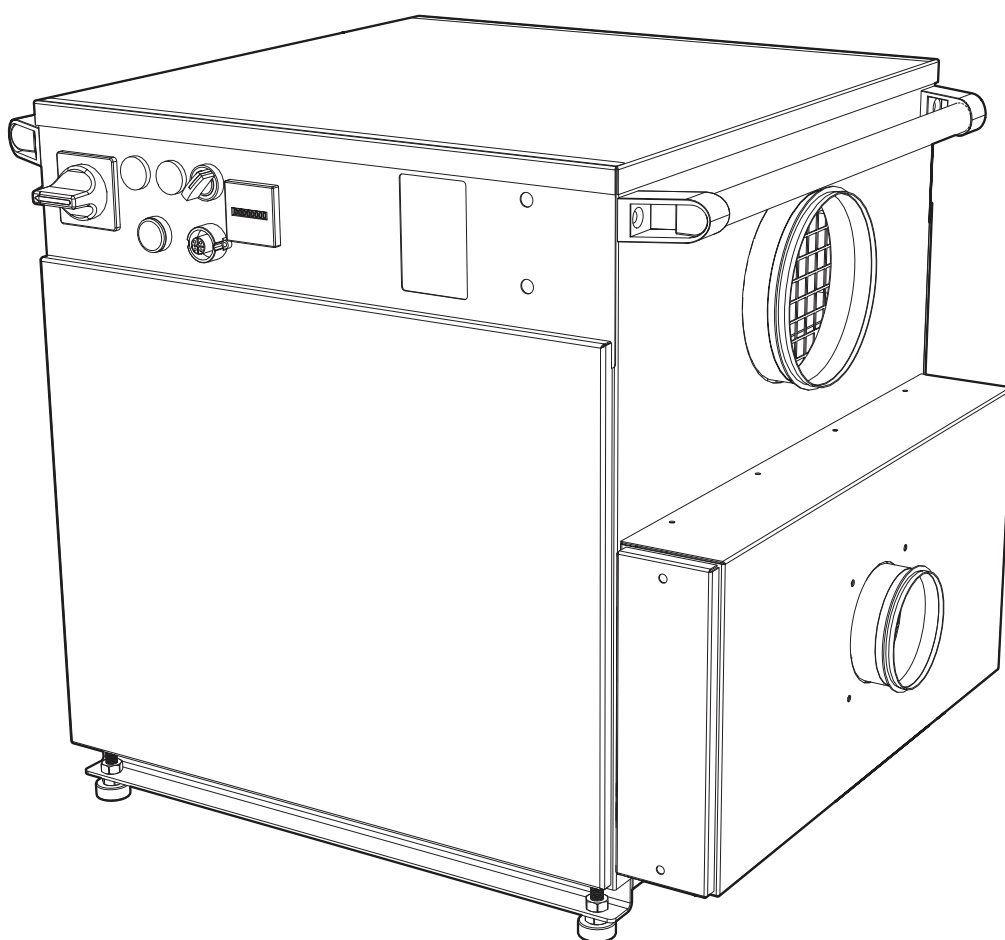

USER'S MANUAL

Document version: EN.05 22.03
Product: DC-50R



CE Desiccant dehumidifier

Product supplied may differ from that illustrated

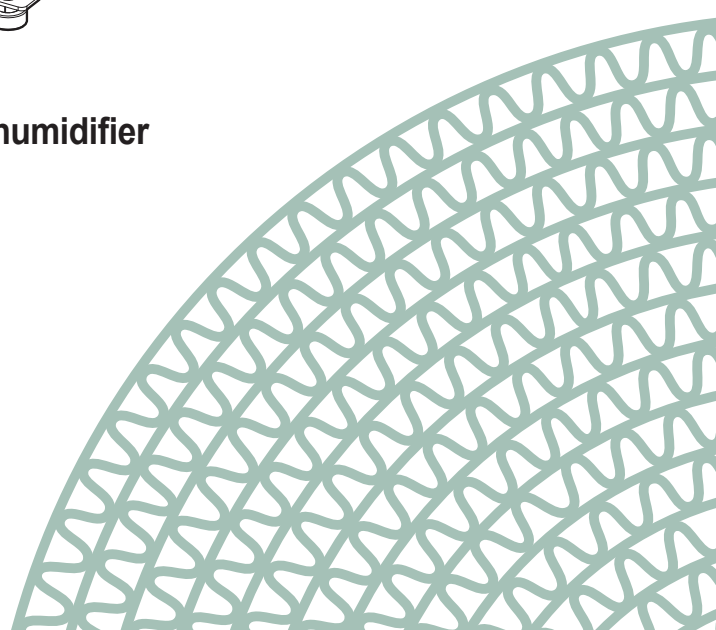

Empty page

Contents

1. Safety	7
1.1 Aim of this document	7
1.2 Emphasised text.....	7
1.3 Intended use.....	7
1.3.1 Hazardous operating conditions	7
1.3.2 Responsibilities of the operator	7
1.3.3 Minimising hazards	7
1.4 Safety	7
1.5 Inspection of goods	7
1.6 Safety advice regarding transportation.....	7
1.7 Installation	7
1.8 Electrical installation.....	8
1.9 Commissioning	8
1.10 Operation	8
1.11 Maintenance.....	8
1.12 Disposal/recycling.....	8
2. Introduction	9
2.1 Type plate overview	9
2.2 Model designation	9
2.3 Serial number structure	9
2.4 Other unit information	9
3. Product description	10
3.1 Product overview.....	10
3.2 Applications.....	10
3.3 Principle of operation.....	10
4. Installation	11
4.1 Unit installation	11
4.1.1 Fork lifting.....	11
4.1.2 Transport.....	11
4.1.3 Positioning	11
4.2 General Duct work installation	12
4.3 Humidistat/electronic controller installation	12
4.4 Electrical connection	12
4.4.1 Power supply.....	12
4.4.2 Earth leakage circuit breaker	12
4.4.3 Humidistat connections.....	12
4.4.4 0-10VDC signal	12
4.4.5 Remote control.....	13
4.4.6 Potential-free signals	13
5. Operation check & adjustment	14
5.1 Pre-operation check	14
5.2 Start-up test and adjustment.....	14
6. Operating	15
6.1 Control panel	15
6.2 Start.....	15
6.3 Stop.....	15
6.4 Reset buttons & switches	15
7. Functions	16
7.1 Dehumidification function.....	16
7.1.1 Automatic or Manual	16
7.1.2 Ventilation modes.....	16
7.1.3 Humidistat connection	16
7.1.4 0-10VDC connection.....	17
7.2 Remote control switch	17
7.3 Temperature safety devices	17
7.4 Regeneration airflow guard	17
8. Option & accessory	18
8.1 Rotation guard.....	18
8.2 Energy saving.....	18
8.3 humidity controller	18
8.4 AUTO/ECO VENT.....	18
9. Troubleshooting	19
9.1 Error codes.....	19
9.2 General troubleshooting.....	19
9.3 Capacity troubleshooting	20
10. Maintenance	21
10.1 Regular service interval.....	21
10.2 Washing the rotor	21
11. Technical data	22

Empty page

Appendix

1. Component list
2. Dimension
3. Harmful chemicals and solvents for rotors
4. CE-declaration

Electrical wiring diagram is stored in the document pocket, depending on the unit, inside or outside the electrical box. The electric diagram has a drawing number. This number should correspond to the sticker with a drawing number found inside the electric cabinet.

If applicable, separate users' manuals for components with separate controls are found in the document pocket.

Figures

FIGURE 1: Type plate.....	9
FIGURE 2: Model name	9
FIGURE 3: Serial number structure.....	9
FIGURE 4: Product overview	10
FIGURE 5: Principle of operation & rotor	10
FIGURE 6: Forks in contact with both sides of the frame.....	11
FIGURE 7: Units with handles	11
FIGURE 8: Exercise caution when lifting and transport a unit	11
FIGURE 9: Humidistat positioning.....	12
FIGURE 10: Control panel.....	15
FIGURE 11: Illustration of automatic and manual functions.....	16
FIGURE 12: Ventilation modes for automatic control	16
FIGURE 13: TH3 with reset button	17
FIGURE 14: EH3T2	18
FIGURE 15: EH4.....	18
FIGURE 16: Troubleshooting table and solution	19
FIGURE 17: General troubleshooting table and solution.....	19
FIGURE 18: Capacity troubleshooting and solution table.....	20
FIGURE 19: Service chart	21

Empty page

1 SAFETY

1.1 AIM OF THIS DOCUMENT

This document accompanies delivery and is therefore an integral part of the equipment. It describes the machine's design and configuration at the time of delivery.

In the interest of safety, please study this document before installing or operating the equipment.

Instructions relating to safety, handling, operation and maintenance must be followed.

Non-compliance can result in serious personal injury or damage to the machinery and may invalidate manufacturers' liabilities and warranties.

This document includes guidance for:

- Installers
- Operators
- Maintenance staff

Please retain this document throughout the lifetime of the equipment.

1.2 EMPHASISED TEXT



Caution! Indicates hazards that could result in damage to the equipment.



Warning! Indicates "potentially" hazardous situations that could result in damage to the equipment, serious personal injury or death.



Danger! Indicates "imminently" hazardous situations that could result in damage to the equipment, serious personal injury or death.



Attention! Indicates important information or instructions that require special attention.

1.3 INTENDED USE

This equipment is specifically designed for atmospheric air drying. It is unsuitable for any other use. For further advice please contact a DST representative.

Unless specifically stated in this manual, the following applications are prohibited:

- conditioning of gases (other than air)
- conditioning of air contaminated with chemicals or aggressive elements
- conditioning of air containing flammable or explosive elements
- in rooms or air systems having a potentially explosive atmosphere (ATEX)
- conditioning of air at elevated pressures
- air entering the rotor that has not been properly filtered with at least G4 class
- compounds in the air that will possibly deteriorate the silica gel rotor - see appendix for detailed information

1.3.1 HAZARDOUS OPERATING CONDITIONS

Operation of the system is deemed to be hazardous if it is:

- not operated inside or is not protected within a weatherproof enclosure.
- not operated within the permitted operating parameters (see technical specifications)
- operated outside the scope of 'normal' use (see intended use)

1.3.2 RESPONSIBILITIES OF THE OPERATOR

It is the responsibility of the operator of the system to ensure that all personnel engaged in the installation, operation, maintenance and service of the equipment have read and understood the relevant sections of this manual.

For your own safety, wear the appropriate personal protective equipment (PPE).

1.3.3 MINIMISING HAZARDS

To ensure that risk to personnel is minimised:

- Ensure that all activities relating to this equipment are carried out by qualified and authorised staff only.
- Identify and prevent potential safety hazards in the environment.

To ensure a failure-free operation:

- Keep this manual ready to hand with the unit.
- Use the machine as intended only.
- Only use the machine if it is fully functional.
- Check the condition of the machine before using.
- Check the machine for operational efficiency at regular intervals.
- Carry out maintenance and testing at prescribed intervals.

1.4 SAFETY

This equipment conforms to the relevant European regulations and directives and is designed and manufactured to be safe and reliable in operation.

The continued safety and reliability of the supplied equipment is entirely dependent on its correct handling, installation, operation and maintenance.

1.5 INSPECTION OF GOODS

Check for transportation damage! Use this product only if you assess it as being undamaged and faultless. Any damage must be recorded by the forwarder at the time of delivery and reported to the supplier of the equipment at the earliest opportunity.

Please check the equipment carefully for damage upon receipt and after removal of all packaging.

1.6 SAFETY ADVICE REGARDING TRANSPORTATION



Warning! Only use tested and certified lifting equipment to offload and position the unit.



Warning! If a forklift is used to move the unit, please ensure the load is evenly balanced.



Warning! If lifting the unit or cassette on a pallet, ensure the unit is firmly secured to the pallet.



Warning! Evacuate and secure the danger area during lifting and positioning of the unit.

1.7 INSTALLATION



Attention! Installation, testing, commissioning and maintenance must be carried out by a qualified person or under the supervision of a qualified person. Wherever possible, all mechanical work must be carried out with the electrical supply switched off.

A qualified person (mechanical) is defined in this manual as:



- a mechanical technician or engineer qualified to service and maintain air conditioning plant and associated systems who
- has completed the appropriate health and safety training
- has read and is familiar with the contents of this manual
- is professionally competent to commission and service this type of equipment.



Caution! The air dryer is designed for internal installation. For external use it will require a weatherproof enclosure.



Caution! The air dryer must be installed on a horizontal plane.

-  **Attention!** The air ducts must be vibration-free and sizable enough to prevent pressure build-up when conveying the incoming and outgoing air from the unit.
-  **Attention!** The incoming and outgoing outlets on the machine are not designed to bear any weight from the air ducts system.
-  **Attention!** The wet air outlet duct must be insulated to prevent condensate and ice build-up in cold conditions.

1.8 ELECTRICAL INSTALLATION

-  **Attention!** Wherever possible, all electrical work must be carried out with the electric supply switched off. It is recommended that electrical isolators be locked in the off position. All electrical work must be carried out by a qualified person or under the supervision of a qualified person.

A qualified person (electrician) is defined in this manual as:

- an electrical technician or engineer qualified to service and maintain air conditioning plants
- has completed the appropriate health and safety training
- has read and is familiar with the contents of this manual.

-  **Danger!** If the unit control panel isolation switch is off, the incoming cable terminals may still be live!

-  **Danger!** If working on the unit's isolation switch, ensure that the electrical power is isolated and locked to prevent accidental resetting.

-  **Danger!** Electrical connections are to be made in accordance with local regulations.

-  **Attention!** Check that the incoming electrical supply conforms to the electrical wiring diagram and the manufacturer's type plate attached to the unit.

-  **Caution!** Loose terminal connections! Due to vibration during transportation it is advised that electrical terminals be checked for security and retightened where necessary. The following connecting terminals in the electrical control cabinet should be checked periodically and retightened if necessary:

- connecting terminals in the main isolator switch
- connecting terminals in main components of the heater circuits
- connecting terminals in main components of the fan circuits

Periodically as defined in this manual means:

- during installation
- during maintenance

-  **Caution!** Parameters used in the electrical protection and alarm circuits must not be modified or adjusted. Factory (default) parameters are shown in the electrical wiring diagrams, technical data or parameter list.

-  **Warning!** This equipment will contain high voltage electrical components!

1.9 COMMISSIONING

-  **Attention!** Equipment fans can produce noise levels above 80 dB (A). Use ear protection if someone are near an operating machine for any length of time.

1.10 OPERATION

-  **Caution!** Use the normal shut-down procedure in the operating chapter. If switching the unit off in an EMERGENCY, the main isolator switch or emergency stop button may be used. However, residual heat from the heater elements will remain in the unit and this can result in damage to components close to the heater.

-  **Caution!** On no account should the unit be operated without air filters installed!

-  **Caution!** Do not expose the unit to an ambient temperature that exceeds 50 °C/122 °F (e.g. inside a plant room) for a long period of time. This may damage the internal components!

-  **Caution!** Do not process air at a temperature higher than 40°C/104°F. This may damage the internal components!

1.11 MAINTENANCE

-  **Caution!** Defective electrical components and defective wiring must be replaced immediately. The equipment must not be operated until the defect has been repaired and the unit has been retested.

-  **Caution!** For maintenance purposes, use the normal shut-down procedure as described in the operating chapter and allow the system to cool down before attempting to access internal components.

-  **Danger!** To prevent unintentional restart, ensure that the main isolator switch is off and the power is isolated before servicing internal components.

-  **Attention!** Advise all operating and maintenance personnel of the automatic restart function if applicable.

-  **Attention!** Pay attention to accessibility requirements for maintenance and service purposes.

-  **Danger!** Only certified personnel are allowed to adjust, repair or modify the unit's refrigerant system. Contact a DST representative for any questions (Econosorb & Frigosorb only).

-  **Caution!** The operation of all electrical safety devices is to be checked at commissioning and during service/maintenance. Under no circumstances are these devices to be deactivated (e.g., during adjustment or bridging).

-  **Caution!** Do not expose the unit to water jets during the washing-down procedure!

-  **Caution!** Do not wash the rotor!

-  **Warning!** Allow the fans to come to a complete stop and the unit to be isolated from the electrical supply before removing any panels!

-  **Warning!** The unit is equipped with a heating element. Do not touch the equipment whilst it is hot. Allow the unit to cool for at least **30 minutes** before any service or maintenance is performed.

-  **Danger!** Manually isolate the unit from the electrical supply by turning the main isolator to "OFF" and secure it with a lock pad before conducting any type of service and maintenance work on the unit

1.12 DISPOSAL/RECYCLING

When the unit is no longer in use, dismantle the unit and recycle the components according to local regulations. Contact a DST representative if you have any questions.

2 INTRODUCTION

2.1 TYPE PLATE OVERVIEW

The manufactured unit is identified by a type plate. The details on the type plate are set out as follows:

1. Model designation
2. Serial number
3. Electrical supply information
4. Regeneration heater power

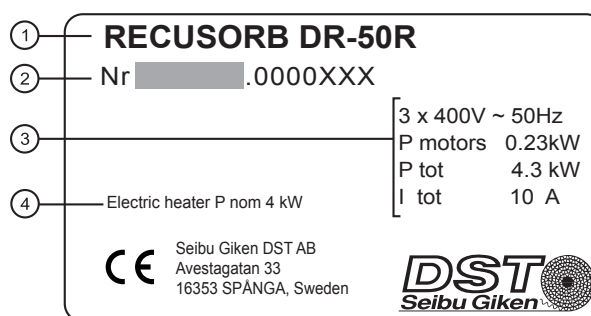

FIGURE 1: Type plate

2.2 MODEL DESIGNATION

The model designation is the name of the model and what type of regeneration the unit is fitted with.

1. Principle type
2. Model name
3. Regeneration heater type - the type of heater the unit is equipped with.*

R = Resistive (electric)	HW = Hot water
G = Gas	WW = Warm water
S = Steam	D = Diesel
	O = Oil

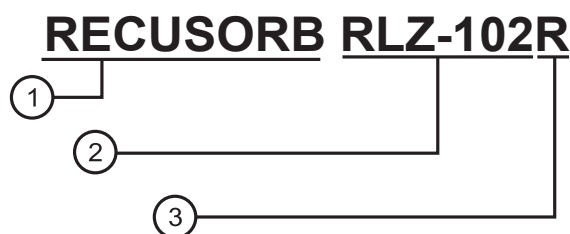

FIGURE 2: Model name

*Not applicable for single-phase unit.

2.3 SERIAL NUMBER STRUCTURE

The serial number is composed of different codes to identify the unit type. Units manufactured pre 2006 have a modified serial number structure which does not match the current structure.

1. Unit (e.g. RLZ-102)
2. Special unit (**aa**) - code to indicate a special manufactured unit
SP = Special
Note: The absence of SP indicates a standard manufactured unit; e.g. RLZ-102SP is a special manufactured unit, and RLZ-102 is a standard manufactured unit.
3. Serial number (**bbbbbbb**) - serial number of the manufactured unit
001, 002, 003, 004... n

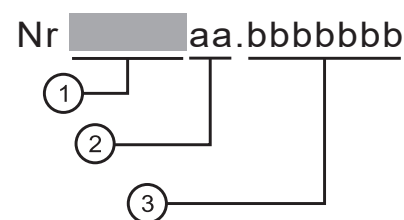

FIGURE 3: Serial number structure

2.4 OTHER UNIT INFORMATION

In the appendix, a component list details spare parts with articlenumbers as well as the electrical diagram number for the electrical box. If there is a special unit with custom-installed components that list will include a list of installed options.

3 PRODUCT DESCRIPTION

3.1 PRODUCT OVERVIEW

1. Control panel
2. Process filter (under the lid)
3. Service panel for electrical cabinet
4. Dry air out
5. Regeneration filter
6. Regeneration air in
7. Service panel
8. Process air in
9. Wet air out

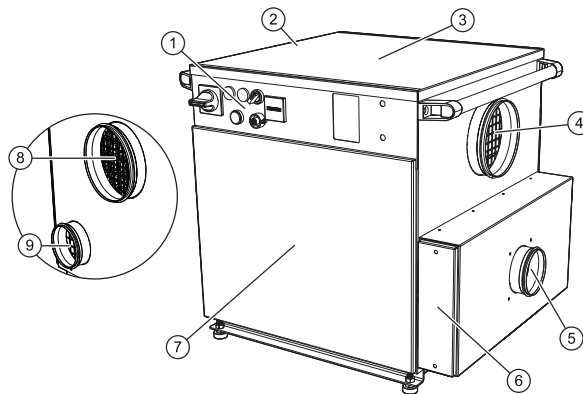

FIGURE 4: Product overview

Variation of installation and components may vary.

3.2 APPLICATIONS

DST desiccant-type dehumidifiers are normally used where dry air is essential to the various manufacturing processes used in chemical, pharmaceutical, food or confectionery industries, or where a dry environment is required for the storing and handling of moisture-sensitive products and raw materials.

The well proven air drying technology using the adsorption principle provides great flexibility in solving humidity problems. It offers the user independent humidity control, down to dew points far lower than the effective operating range of refrigeration dehumidifiers.

3.3 PRINCIPLE OF OPERATION

It works on a continuous process with two air streams of different flow rates, normally having a flow ratio of approximately 4:1. The greater flow, *process air*, is dried as it passes through the dehumidifier, while the smaller flow, *regeneration air*, is used to heat the rotor material to evaporate the adsorbed moisture vapour from the desiccant. The moisture which is removed from the process air, is transferred over to the other sector as the rotor turns slowly.

1. Wet air outlet
2. Regeneration air fan
3. Regeneration sector
4. Regeneration heater
5. Regeneration air in
6. Dry air outlet
7. Process air fan
8. Rotor motor
9. Process sector
10. Rotor
11. Process air inlet

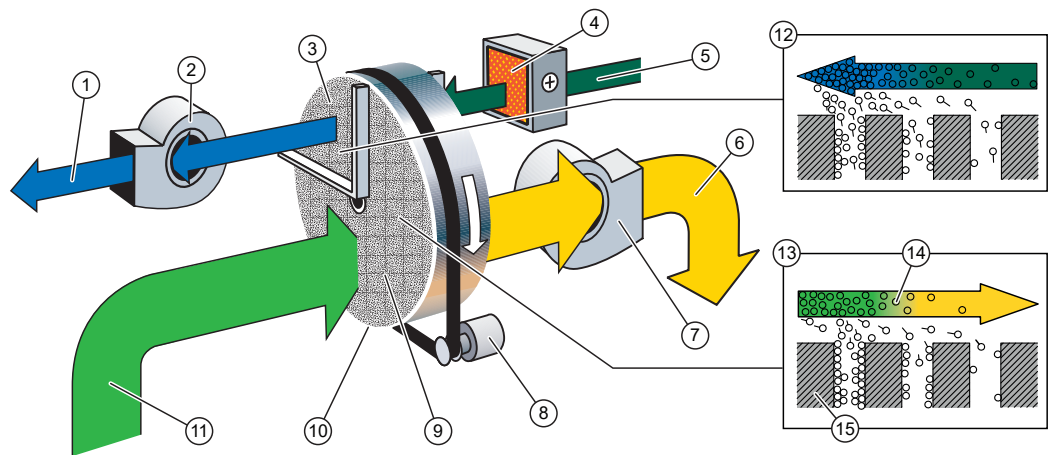

CONSORB is a continuous dehumidifier able to reach very low dew points. The rotor is divided by seals into two separate air sectors, process and regeneration. The process air is dried by adsorption in the process sector. The regeneration air is first heated by the regeneration heater before it flows into the regeneration sector where it evaporates the adsorbed moisture vapour and drives it out of the rotor.

FIGURE 5: Principle of operation & rotor

4 INSTALLATION

4.1 UNIT INSTALLATION

Follow the directions regarding installation of heavy and medium weight dehumidifiers.

Note: Use the installation guidelines as a reference only.

4.1.1 FORK LIFTING

The unit can be off-loaded and positioned using a fork lift by lifting between the feet of the unit, alt., on some dehumidifiers, lift the unit using the built-in handles.

- The forks must be of sufficient length to be in contact with both sides of the base frame.
- The forks should be initially positioned centrally across the middle sections of the unit but must be checked for balance prior to final lifting.
- Units equipped with handles are very heavy. Do not lift the unit single-handedly! Always ask for assistance or use lifting aid!

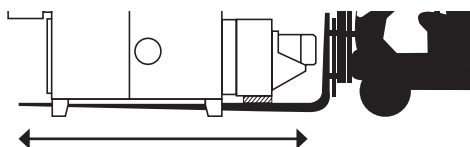

FIGURE 6: Forks in contact with both sides of the frame.

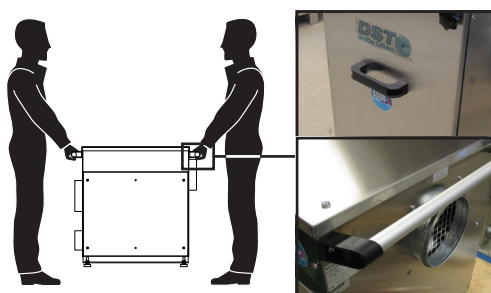

FIGURE 7: Units with handles

4.1.2 TRANSPORT

Dehumidifiers with external fans or a high centre of gravity runs the risk of tipping. Use caution when lifting and moving the dehumidifier.

Note:

- Secure any panels, doors or loose equipment.
- Keep the unit balanced at all times when moving the unit.
- See safety chapter regarding lifting safety.

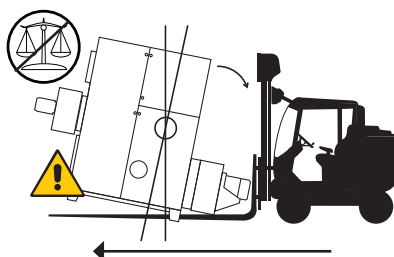

FIGURE 8: Exercise caution when lifting and transport a unit

If not balanced, the unit may run the risk of tipping during transport.

See "11 Technical data" for weight information.

4.1.3 POSITIONING

Position the machine with adequate working space around the unit to allow inspection and service. Size of unit and the position of the access panels/doors vary depending on the model. To avoid incorrect positioning, see the dimensional drawing in the appendix for service space and foot bolt-hole dimensions.

4.2 GENERAL DUCT WORK INSTALLATION

The guidelines are to assist the installers and operators to adjust the duct/dehumidifier installation. Consult a DST representative or local mechanical installation company for more information.

- Avoid recirculation from the separate airflows, direct entering and exiting airflow away from each other.
- Check if the dry air is well distributed in the dehumidified area.
- The regeneration air in and wet air out has to be connected to the outside of the dehumidified area, preferable outdoor.
- To increase the lifetime of the filter, it is recommended taking air from a higher level where dust and other particles are kept at minimum.
- Install dry air out duct/channel at a high level.
- To maximize the drying capacity, free blowing on dry air out without airflow reduction is recommended.
- Allow wet air to disperse freely when exiting the duct.
- It is recommended to insulate the wet air duct.
- The wet air duct must be installed at a sloping outwards angle, due to risk of condensation inside the duct work. The setup will also prevent condensation flowing back into the dehumidifier.
- If the duct needs to be installed higher than the wet air outlet, fix a condensate drain at the lowest point of the duct.
- Do not connect the air outlet to a ventilation system which can create pressure that will result in reverse airflow through the dehumidifier.

4.3 HUMIDISTAT/ELECTRONIC CONTROLLER INSTALLATION

Install the humidistat/electronic controller away from the dry air out path to avoid false readings.

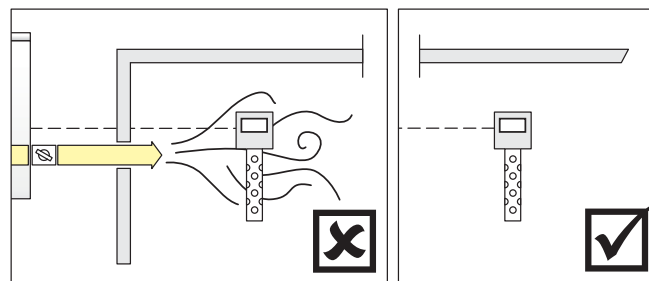

FIGURE 9: Humidistat positioning

4.4 ELECTRICAL CONNECTION

Electrical components should be connected to the supply according to the local regulations and requirements.

4.4.1 POWER SUPPLY

The incoming three-phase cable with L1, L2 and L3 are directly connected to the main switch and PE-cable connected to the earth bar.

The electrical feed must be provided on-site in accordance with the electrical diagram and local requirements.

See electrical diagram for a detailed layout and description.

4.4.2 EARTH LEAKAGE CIRCUIT BREAKER

Due to the high capacitive currents present in the AC drive, earth leakage circuit breakers may not function properly.

Note: This is only applicable if the unit is equipped with a frequency converter.

4.4.3 HUMIDISTAT CONNECTIONS

The dehumidifier has a connection for a 1-step* or 2-step** humidistat. This is optional for some models.

See electrical diagram for connections.

See "7 Functions" for more details.

*For models with no selectable heater output.

**For models with at least two selectable heater output.

4.4.4 0-10VDC SIGNAL

Units with optional connections points for an electronic humidity controller or another regulator signal is marked on the electrical diagram.

See "7 Functions" for more details.

See electrical diagram for connections.

4.4.5 REMOTE CONTROL

The unit has a connection point for a remote switch.

See electrical diagram for connections details.

See "7 Functions" for more details.

4.4.6 POTENTIAL-FREE SIGNALS

Potential free contacts are marked on the electrical diagram for connecting external indicators. These indicators are used to transmit signals to a remote centre, to indicate if unit or fans are still in operation.

Standard indicator

- Alarm indicator
- Run indicator*
- Regeneration fan indicator*
- Process fan indicator*

Optional indicators (N/A for certain units)

- Filter guard (regeneration) indicator
- Filter guard (process) indicator
- MAN/AUTO indicator

Each indicator, standard or optional, are marked on the electrical diagram to indicate whether it is a normally closed or a normally opened circuit.

*Standard indicator may differ depending on model and configuration. See electrical diagram for more information.

5 OPERATION CHECK & ADJUSTMENT

5.1 PRE-OPERATION CHECK

Danger!

The operator of the system must ensure that all personnel who are involved with installation, operation and maintenance of the machine have read the "1 Safety" sections of this manual.

1. Inspect and clean the inside of the unit from foreign objects such as rags, tools, particles of metal, and such, that may pose damage to the inside of the unit.
2. If fitted, ensure that both air balance dampers are fully open and check that the air paths of the duct work are not obstructed in any way.
3. Check that the filters are securely in place.
4. Confirm both motor overload protectors are set to Start/On position.
5. If fitted with condenser or cooler, install a water trap.
6. Confirm thermostat and overheat protection settings are in accordance with table shown "11 Technical data".
7. Confirm the incoming electrical power cable is secure and ensure that live wires are securely located in the correct terminals. Ensure the earth wire is securely located onto the earth strap or earth terminal provided.
8. Check that the rating of the electrical supply fuses is correct, see wiring diagram.

5.2 START-UP TEST AND ADJUSTMENT

1. Close and secure all access doors
2. Switch the main switch to "I" and check the supply voltage is correct.
3. Briefly start the unit and then turn it off. Promptly check if the process fan and regeneration fan is rotating in the correct direction. If incorrect check "9 Troubleshooting". See "6 Operating" on "Start" and "Stop".
4. If fitted, balance the airflows, using the dampers in the duct work or adjust the frequency of each frequency converter to obtain the required values.
5. Check the operation of fault alarms by temporarily reducing the setpoints of alarm giving thermostats and motor protectors. Do not forget to reset to the original settings according to technical data and electrical diagram.
6. Measure the current on both fans and compare with the electrical specifications printed on the fan motor casing. If the current is too high, reduce the airflow slightly by closing down on the respective balance damper.
7. If connected, check remote control operation.
8. If connected, check remote alarm function (see 5 above).
9. If connected, check humidistat/electronic humidity controller function.

6 OPERATING

6.1 CONTROL PANEL

1. [ALARM] - Alarm light
2. [0 RESET/1] - ON/OFF switch*
3. [AUTO/MAN] - Mode switch for AUTO or MAN
4. [MAIN] - Main switch
5. Emergency stop button
6. Humidistat connection
7. Runtime meter
8. [TH1] - Safety thermostat for regeneration heater - Reset switch
9. [TH2] - Control thermostat for regeneration heater

*The light indicator turns on each time the regeneration heater is active.

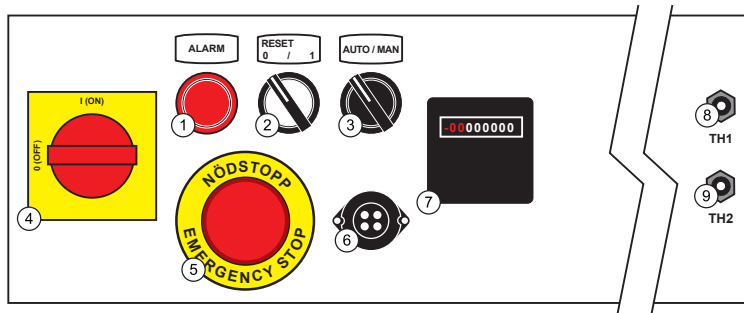

FIGURE 10: Control panel

Note: Control panel layout - for guidance only. Panel supplied may differ from that shown.

6.2 START

Start the unit.

1. Turn [MAIN]-switch to "I".
2. Turn [AUTO/MAN]-switch to "MAN" for continuous dehumidification or "AUTO" for automatic-mode with connected humidistat/regulator signal.
3. Turn [0/1] to "1" and the unit starts running.

⚠ Caution!

When "Automatic restart" selected. The unit starts automatically after a power failure. It is important that all personnel involved with installation, operation, maintenance and service of the unit are made aware of this function.

6.3 STOP

Unit will shut down.

-A timed cooling down period on the regeneration fan is initiated before turned off.

1. Turn [0/1] to "0".

⚠ Caution!

Do not use the main isolator switch to turn off the unit. Always use the described stop procedure to turn off the unit.

6.4 RESET BUTTONS & SWITCHES

Fuses, overheat protections or motor protectors are found inside the electrical cabinet. The position and denotation of the devices may vary depending on the unit and configuration.

Reset is only required when a operation is halted by hardware failure or triggered a safety mechanism. See troubleshooting for more information.

See the electrical diagram for correct layout and information of the reset devices.

7 FUNCTIONS

7.1 DEHUMIDIFICATION FUNCTION

The unit is equipped with multiple modes to control the dehumidification. It allows automatic control with connected humidistat or regulator signal*, or manual override. A selectable option to set the ventilation modes during automatic mode is also possible.

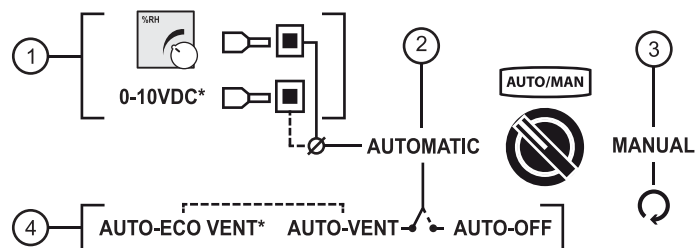

1. Connections for a humidistat or regulator signal when controlling the dehumidification.*
2. Automatic control - Dehumidification is automatically controlled using a humidistat or regulator signal
3. Manual control - Dehumidification is manually controlled using pre-set settings.
4. Selectable ventilation mode when dehumidification stops.

* Option

FIGURE 11: Illustration of automatic and manual functions

7.1.1 AUTOMATIC OR MANUAL

Main operation control is operated by selecting automatic or manual mode on the [AUTO/MAN]-switch.

AUTOMATIC [AUTO] - Dehumidification capacity is controlled automatically by a humidistat/regulator signal. A user selectable ventilation mode to save energy or to ventilate when the dehumidification need is achieved.

MANUAL [MAN] - The unit will run on selected settings until manually turned off. This mode will also prevent a humidistat or a regulator signal from shutting down the unit.

Note: Electrical heater output is selectable. Available for certain models only. See "6 Operating".

Note: AUTO-mode is only operable when a humidistat/regulator signal is connected.

Note: If the unit is fitted with Energy saving, the regeneration heater will operate on full effect in MAN-mode.

7.1.2 VENTILATION MODES

In automatic mode, the unit can operate in two different ventilation modes when the dehumidification automatically stops. The unit will automatically start dehumidify again when the humidity rises above the setpoint on the humidistat or regulator signal.

- **AUTO-VENT** is a ventilation mode that provides a constant airflow by keeping the process fan running.
- **AUTO-ECO VENT*** is a semi-ventilation mode that provides an airflow in intervals by turning the process fan ON and OFF.
- **AUTO-OFF** is not a ventilation mode, unit stops all fans and is powered down to a sleep mode.

AUTO-VENT	AUTO-ECO VENT*	AUTO-OFF	

Note: When the dehumidification stops, a timed cooling down period on the regeneration fan will be initiated to remove potential residual heat from the heaters. See cooling down timer in "11 Technical data".

Note: Factory default setting on ventilation mode varies among models. For units with PLC, mode is adjusted in the PLC. For units without PLC, change the mode by changing the terminal link wire inside the electrical cabinet. See electrical diagram for default ventilation mode on the unit.

FIGURE 12: Ventilation modes for automatic control

The default time setting for the process fan is: **ON** (5 min) and **OFF** (55 min). Adjusting the time setting is only possible with a PLC installed, without a PLC the default time setting applies.

Note: AUTO ECO VENT is an option but it is included for DC/DR-50 and RL-60/61/71 when Energy saving 2 or 3 is selected.

* Option - Contact a DST representative for more on information on which unit can be fitted with AUTO-ECO VENT.

7.1.3 HUMIDISTAT CONNECTION

Standard units have the option to use the built-in Humidistat inputs to control the dehumidification using a 1-step humidistat.

Use a 1-step humidistat for heating output in two steps (maximum power and zero power).

Mode	One-step humidistat	
	Humidistat inputs	Output
1	Humidistat (Closed)	Full power
2	Humidistat (Opened)	Zero power*

7.1.4 0-10VDC CONNECTION

Note: Option

This feature replaces the standard built-in humidistat inputs when Energy saving 2 or 3* is fitted. A 0-10VDC regulator is used to control the dehumidification capacity on a precision level when the built-in Humidistat input feature is insufficient.

Electronic humidity controller	Regulator signal	Capacity output
EH3 T2/others	0...10VDC	0...100%

See electrical diagram for customer connection.

* N/A for R-51/60/61, RL-60/61/71.

See "8.2 Energy saving" for more feature description.

7.2 REMOTE CONTROL SWITCH

Connections for a external power switch is available as standard. The remote power switch allows the user to shut down or turn on the unit from another location.

Note: The external power switch overrides the manual and automatic mode and must be restored to start the unit.

See electrical diagram for connections.

7.3 TEMPERATURE SAFETY DEVICES

Integral "fail-safe" temperature devices will protect the unit from damage caused by component failure, incorrect settings or abnormal operating conditions.

Type	Thermostat function	Thermostat description	Thermostat location	Reset is required
TH1	Safety thermostat	An overheat protection device that stops the unit if the temperature exceeds the set limit	Inside the regeneration heater compartment	Yes
TH2	Control thermostat	A device that controls the set regeneration temperature	Inside the regeneration heater compartment	No
TH3	Safety thermostat	An overheat protection device that stops the unit if the temperature exceeds the set limit	In the proximity of wet air outlet	Yes

Temperature device types used will vary between models fitted with a PLC and those without a PLC. See below.

Units with PLC	Units without PLC
Two shielded electronic sensors, programmed on PLC as TH2 and TH3. Reset TH3 on PLC. Mechanical thermostat TH1* – reset on thermostat.	Only mechanical thermostats installed - TH1, TH2 and TH3 Mechanical thermostat TH1* and TH3 - reset on thermostats.

*N/A when fitted with coils.

See "11 Technical data" for default temperature settings.

See electrical diagram for the location of the thermostats.

! Attention!

If TH1 or TH3 are tripped, an automatic safe shut down procedure will be initiated. On units fitted with a PLC an alarm code will be displayed. On units without a PLC an alarm is indicated by a red light on the control panel. The shut down procedure includes a timed cooling down period and, if fitted, closing of associated valve actuators.

! Attention!

Should TH1 trip, it will automatically disable the regeneration heater circuit breakers. These must be reset before attempting to restart the unit.



FIGURE 13: TH3 with reset button

Additional safety thermostats is placed inside the unit, next to the process fan. The reset button is located on top.

7.4 REGENERATION AIRFLOW GUARD

The fail-safe device automatically turns off the the regeneration heater from overheating due to insufficient regeneration airflow. The pressure switch is adjustable but it is not recommended. See "11 Technical data" for default setting.

The airflow guard is a warning only and will not shut down the unit or turn on a alarm light. If there is a potential reduced capacity, see "9.3 Capacity troubleshooting" to locate the issue.

8 OPTION & ACCESSORY

8.1 ROTATION GUARD

A safe guard feature that stops the unit from overheating in case of a sudden stop in the rotor rotation. The rotation guard will stop the unit and turn on an alarm indicator or display an error message on the PLC.

Note: Included in Energy saving 2 and 3.

8.2 ENERGY SAVING

To save energy, the unit can be fitted with different "Energy saving" features.

Energy saving 1: The reactivation heater power output is regulated in two steps. Using a EH3 T2 or EH4 to adjust the drying capacity between High, Low & Off, as required to maintain the humidity (or dew point) between two programmable setpoints.

Energy saving 2: The reactivation heater power is fully regulated between zero and full capacity using either binary (multi-step) or linear (triac or actuator) control. Using a humidity controller EH3 T2 + PLC C2 or an external control signal (BMS + PLC C2), the drying capacity is finely adjusted to accurately maintain the required setpoint (humidity or dew point).

Contact a DST representative to view the energy saving option for each specific unit as options across the products range may vary.

8.3 HUMIDITY CONTROLLER

Control the dehumidification process using the advanced electronic humidity controller EH3 T2 or the simpler electronic humidistat EH4. The devices can be built in the electrical box next to the control panel or loose device for on-site installation.

See "8.2 Energy saving" for more information on what features they can be installed on.

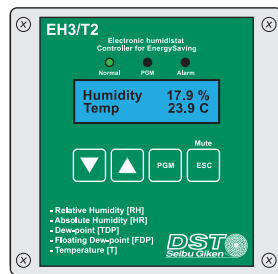

FIGURE 14: EH3 T2

Electronic humidity controller with multiple settings and advanced control for dehumidification,

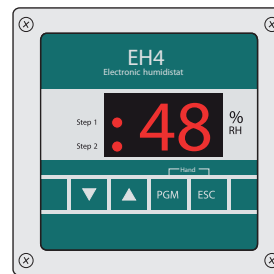

FIGURE 15: EH4

2-step humidistat for less demanding dehumidification control.

Note: Data sheet and user's manual is available separately.

8.4 AUTO/ECO VENT

AUTO-ECO VENT is a semi-ventilation mode that provides an airflow in intervals by turning the process fan ON and OFF.

The default time setting for the process fan is: **ON** (5 min) and **OFF** (55 min). Adjusting the time setting is only possible with a PLC installed, without a PLC the default time setting applies.

Note: Included in Energy saving 2.

9 TROUBLESHOOTING

9.1 ERROR CODES

The dehumidifier will automatically shut down if an error is detected. During shut down, a timed cooling down period on the regeneration fan is initiated before turned off. See below for error codes.

CODE	EXPLANATION	CAUSE	SOLUTION
If the unit stops and the ALARM-light is lit, check following.	Overload in the transformer	Short-circuit or transformer malfunction.	Check fan. Check rotor motor. Check transformer (F40). Reset F40. Check cables. Have a qualified electrical technician to investigate.
	Regeneration air thermostat TH1 has tripped. Regeneration heater overloaded (F1). Note: Not applicable when fitted with steam.	TH1 setting incorrect. TH1 defective (fail safe). Incorrect shut down. Insufficient regeneration airflow. Excessive regeneration heater power. Regeneration heater malfunction. Note: Not applicable when fitted with steam.	Check TH1 setting. Check correct operation of TH1. Reset TH1 - reset F1. Check regeneration airflow and fan operation. Check TH2 setting. Check and replace heater. Note: Triggered TH1 will also trigger F1. Note: Not applicable when fitted with steam.
	Wet air thermostat tripped (TH3).	TH3 setting incorrect. Excessive regeneration airflow. Excessive regeneration heater power. Incorrect or intermittent rotor rotation. Insufficient system moisture load.	Check TH3 setting. Reset the TH3. Check and adjust regeneration airflow. Check TH2 setting. Check rotor drive system. Check process airflow and fan operation. Check process inlet moisture content. Check RH controller setpoint/output control signal.
	Rotation guard sensor has not detected movement.	Rotor motor and/or rotor gear failure. Belt transmission/slipping belt. Sensor failure or distance too great between sensor and contact screw.	Check the rotor motor and its gear. Check if the belt intact or slipping on the belt pulley and/or rotor. Check the sensor for defect and adjust the distance to the contact screw. Turn the [0/1]-switch to "0"-position and main switch to "0/OFF"-position to restore.
	Frequency converter alarm. Note: Option	Frequency converter internal alarm activated.	Refer to converter manual for fault code explanation.
EMERGENCY STOP BUTTON is lit.	Operation terminated.	Emergency button activated. [0/1]-switch is active.	Pull the emergency button to restore. Turn the [0/1]-switch to "0"-position to restore.

FIGURE 16: Troubleshooting table and solution

9.2 GENERAL TROUBLESHOOTING

Check for following if the unit will not start-up.

PROBLEM	CAUSE	SOLUTION
Unit will not start. None of the light indicators are on.	No power to unit. No power to control circuit. The emergency stop button is active.	Confirm electric supply and check local isolator is on. Check remote control is set to 'On/Run' position. Check all circuit breakers are set to 'Start/On' position. Pull the emergency stop button and then turn the operating switch to "0".
The ALARM-light is on but the unit will not start.	Alarm circuit is preventing start-up.	Check TH1 & TH3 thermostats are set. Check all circuit breakers are set to 'Start/On' position. Check fan motor overloads are set to 'Start/On' position.
The dehumidifier is turned on but does not appear to be operating.	A circuit is preventing operation.	Operation can be checked by lowering control setpoint or switching to 'manual' operation. Check remote control is set to 'On/Run' position and if the cable is undamaged. Confirm electric supply and check local isolator is on.

FIGURE 17: General troubleshooting table and solution

9.3 CAPACITY TROUBLESHOOTING

The dehumidifier performance can be roughly checked by feeling the temperature of the uninsulated duct work near the unit.

PROBLEM	OBSERVATION	SOLUTION
The dehumidifier does not maintain required condition or achieve expected performance, despite being operated at full power.	Dry air outlet duct is warm and wet air outlet duct is very warm (normal operation).	<ul style="list-style-type: none"> Check actual moisture load against calculated design moisture load. Check controller setpoint/output signal. Check airflows are set as specified, adjust as necessary. Check air filters. Check dehumidifier casing and duct work for air leakage. Check rotor alignment and condition of radial and peripheral rotor seals.
	Both outlet air ducts are cold (no alarm).	<ul style="list-style-type: none"> Check regeneration airflow and fan operation. Check regeneration heater operation. Check controller setpoint/output signal. Check TH2 setting.
	Dry air outlet duct is cold, wet air outlet duct is hot (no alarm).	<ul style="list-style-type: none"> Check rotor rotation. Check process airflow and fan operation.
	The regeneration heater light indicator is not turning on or flashing.	<ul style="list-style-type: none"> Check regeneration airflow - Remove blockages or open dampers on the regeneration airflow. Check pressure switch and setting. Note: N/A for R-51/60.
	None or low regeneration airflow is detected.	<ul style="list-style-type: none"> Check regeneration fan. Check TH2 thermostat and setting. Check TRIAC and cooling fan.
Measured airflows are lower than specified.	Fan is not rotating in direction indicated by arrow on fan motor casing. The incoming phase supply is incorrect.	<ul style="list-style-type: none"> Isolate mains electrical power supply to the unit. Change over two of the three incoming phase supply wires. Re-check fan rotation.

FIGURE 18: Capacity troubleshooting and solution table

10 MAINTENANCE

10.1 REGULAR SERVICE INTERVAL

Service time	Run time in hours (x1000)	0	4'	8'	12'	16'	20'	24'	28'	32'	36'	40'	44'	48'
	Calendar time in months	0	6	12	18	24	30	36	42	48	54	60	66	72
Inspect filter - replace if necessary		X	X	X	X	X	X	X	X	X	X	X	X	X
Clean and inspect the unit				X		X		X		X		X		X
Inspect fan - replace if necessary				X		X		X		X		X		X
Inspect features and functionality		X		X		X		X		X		X		X
Inspect electric, feature, cables and electrical components - replace if worn or damaged				X		X		X		X		X		X
Inspect access panels, locks and panel seals - replace if necessary				X				X				X		
Inspect duct and duct connections		X				X				X				X
Inspect heater and cooler				X		X		X		X		X		X
Inspect humidistat/humidity sensor - replace if necessary				X		X		X		X		X		X
Inspect rotor motor - replace if necessary				X		X		X		X		X		X
Inspect radial & peripheral seals - replace if worn or damaged				X		X		X		X		X		X
Check operation of geared drive motor, drive pulley, belt/chain, rotor - adjust as necessary				X		X		X		X		X		X
Inspect rotor for contamination or damage - clean/repair (contact DST)		X		X		X		X		X		X		X
Inspect condenser*				X		X		X		X		X		X
Inspect evaporator*				X		X		X		X		X		X
Inspect compressor*				X		X		X		X		X		X
Inspect cooling system*		X		X		X		X		X		X		X

Safety feature check (if fitted)														
Function test on thermostats			X		X		X					X		X
Function test on the freeze alarm	X		X		X		X		X		X		X	X
Function test on rotation guard alarm, check and adjust sensor clearance	X		X				X					X		
Function test on damper, actuator and valves	X		X		X		X		X		X		X	X
Function test on post-cooling function	X		X		X		X		X		X		X	X

FIGURE 19: Service chart

This is a general service chart and the time interval vary depending on the operating condition. Some options listed here may not be installed or available for this specific unit.

Danger!

All personnel involved with installation, operation and maintenance of this unit should familiarise themselves with the safety section of this manual.

*Applicable for Frigosorb and Econosorb.

10.2 WASHING THE ROTOR

The D-MAX rotor has a distinct advantage over other types of desiccant rotors in that dust and grease can be washed out of the material without the need for reimpregnation after treatment. In all normal applications however it must be emphasised that washing of the rotor should be considered as a last resort having alleviated all other possible defects first.

Caution!

Please contact a DST-representative before attempting to wash the rotor!

11 TECHNICAL DATA

Capacity	
Capacity [kg/h]	¹ 3
Nominal dry air flow [m ³ /h]	² 550
External static pressure dry air [Pa]	² 150
Nominal wet air flow [m ³ /h]	² 150
External static pressure wet air [Pa]	² 100
Regeneration heater - Electric	
Heater power [kW]	5
Number of electric heater steps	1
Heating power in steps [kW]	-
Heating power with linear control [kW]	⁴ 0-5
Total power - Electrical	
Total motor power [kW]	0.38
Total power [kW]	5.38
Other electrical information	
Supply fuse 3x400V/50Hz [A]	16
Humidistat connection	230VAC
Humidistat supply current [A]	⁵ < 1
Temperature setpoint settings	
Overheat protection TH1 [°C]	190
Thermostat TH2 [°C]	160
Overheat protection TH3 [°C]	75
Temperature limits	
Max. process air inlet temperature [°C]	40
Max. operating temperature [°C]	50
Min. operating temperature [°C]	-20
Other technical data	
Air filter class (regeneration/process)	G4/G4
Filter change at pressure (G4/F7) [Pa]	⁶ 200/250
Airflow guard - Regeneration [Pa]	30
Noise level [dB(A)]	³ 60
Regeneration air fan delay [min]	10
Weight [kg]	63

¹ Valid for inlet conditions 20 °C/60%RH (equal 1.2 kg/m³).

² If no data is stated here the volume flow above is given at free blowing airflow.

³ Unit connected to uninsulated ducts. Nominal airflows.

⁴ Applies for dehumidifiers with installed optional feature.

⁵ The current provided by the humidistat connection. Only use humidistats that are capable of this load current.

⁶ (EN779 = ISO16890) G4 = Coarse 60%, M5 = ePM10 60%, F7 = ePM1 60%, F9 = ePM1 85%

The content of in this document may be subject to change without prior notice. For questions and comments regarding the content in this document, please send it to

Seibu Giken DST AB, ATT: Documentation, Avestagatan 33, 163 53 SPÅNGA, SWEDEN.

E-mail: info@dst-sg.com, subject: Documentation.

Component list DC-50R

Description	Type, Drwg No etc	Qty.	Art No	Notes
Rotor unit				
Rotor	DMR 450H05	1	108251	
Peripheral sealing	1470x47x1 50SH	1	107955	
Teflon sealing	35x203mm	1	106392	
Teflon sealing	35x242mm	2	106393	
Teflon sealing	35x243mm	2	106394	
Hose clip	length=1,5 m	1	103345	
Brushsealing	DX1175-13mm	2mtr	102851	
Rotor motor	ASM 16 FG 230V 50/60Hz 0,27μF	1	112687	
Capacitor	0,27μF (incl. in motor)	1	-	
Drive belt	HTD 1595 5M 09	1	102586	
Belt pulley	HTD 36 5M 09; d=8mm; 2xM5	1	105379	
Fans				
Process fan	R2E250-RB06-01; 230V 50/60Hz; 250W; 1,1A	1	107978	
Capacitor	5μF (incl. in fan)	1	-	
Regeneration fan	G2E 140 -NI28-47, 230V; 50/60Hz 155W; 0,68A; 2400rpm	1	105696	
Capacitor	4μF (incl. in fan)	1	-	
Regeneration heater				
Reg heater	230/400V; 50/60Hz; 3 kW	1	101069	
Reg heater	230/400V; 50/60Hz; 2,0 kW	1	105380	
Filter				
Filter media	G4 530x260 mm	1	105214	Process
Filter media	G4 530x200 mm	1	109977	Regeneration
Other / Övrigt				
Amphenol connector		1	100392	
Amphenol connector, cap		1	100416	
Electric box	Dwg. No: 10710-02	1	108830	
Inlet nozzle 250	96359-2-4013	1	107979	
Wet air hose	D=100 x L= 250 mm	1	102898	
Cable for pressure switch		2mtr	107093	
Bracket for pressure switch		1	DST05756	
Adjustable feet	M10x40 Black	4	106197	

Using this drawing for any other purpose without the written consent of DST is strictly prohibited.

Appr. 1 metre free service space, above, front and rear side

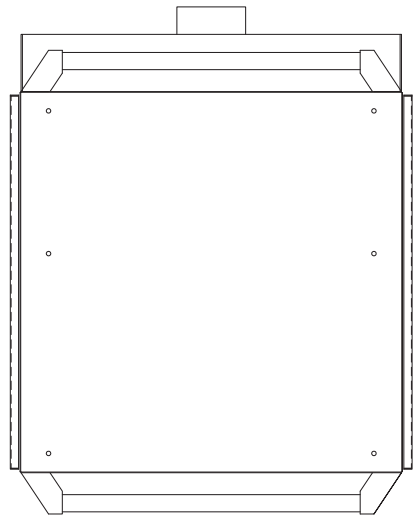
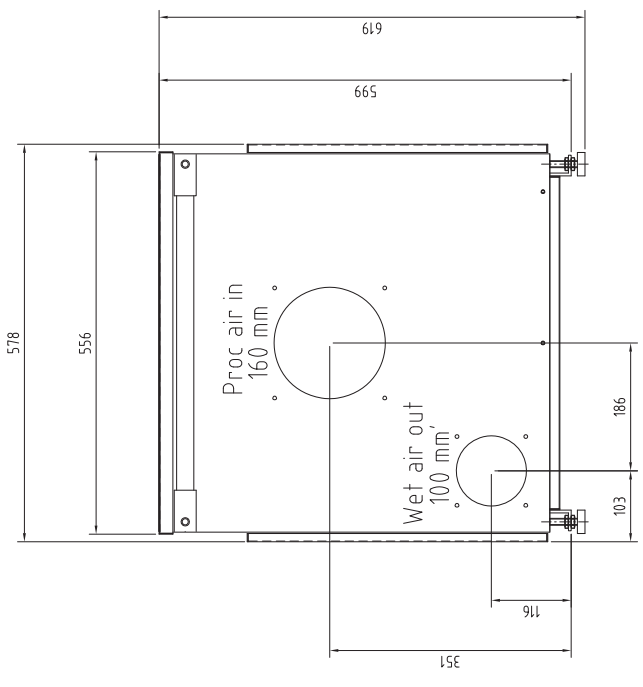
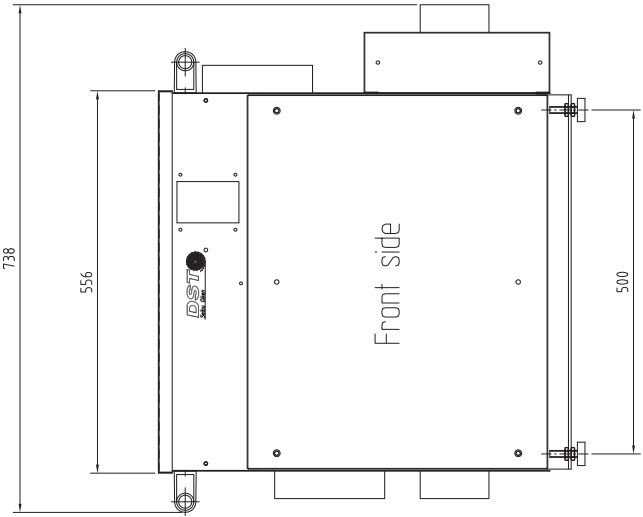
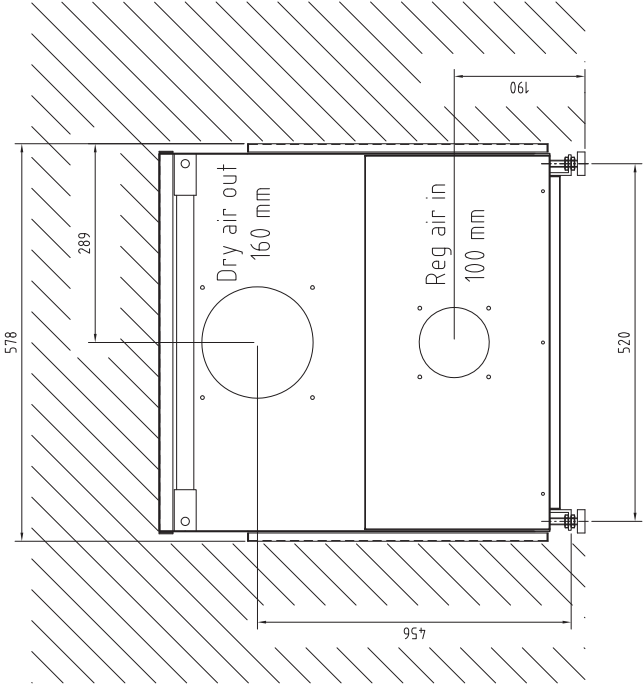

Rev	Art	Reasoning	Date	Int	Lock
01		Mounted feets	08-12-04 AL		
02		Service area added	10-06-14 AL		
03		Added unit weight	12-12-06 SO		

Date	Art.	Reasoning	Material	Dimension/Unit	Amakshing	State	Year	Drawn	Scale	Project
				63kg		UJ	2005-11-30			050 1 9121-03

DST
Sistem Cipta
DC-50R
Dimension drawing

Harmful chemicals and solvents for rotors

SEIBU GIKEN CO.,LTD.

Reduced performance and/or rotor degradation is possible when adsorping the following substances.

	Substance	Note	Chemical formula	Cause
1	Oil vapor		N/A	Cloggs the micro pores on the silica gel/zeolite.
2	Ammonia	2ppm and above, prolonged exposure	NH ₃	Degrades the silica gel/zeolite.
3	Amine		RNH ₂	
4	Hydrogen fluoride		HF	Corrodes the silica gel/zeolite.
5	Sodium hydroxide	High concentration	NaOH	Dissolves the silica gel/zeolite.
6	Potassium hydrate	High concentration	KOH	Cloggs the micro pores on the silica gel/zeolite.
7	Lithium chloride		LiCl	
8	Sodium chloride		NaCl	
9	Potassium chloride		KCl	
10	Calcium chloride		CaCl	
11	Magnesium chloride		MgCl	
12	Aluminum chloride		AlCl ₃	
13	Seawater		N/A	
14	Strong acid	pH=3 and below	N/A	Deteriorates the honeycomb's physical structure.
15	Plasticizer		N/A	Cloggs the micro pores on the silica gel/zeolite.
16	Nitrogen oxides	High concentration, excessive exposure	NO _x	Deteriorates the honeycomb's physical structure.
17	Sulfur oxides	High concentration, excessive exposure	SO _x	
18	High-temperature steam	Exposod to vapor of 100 and above.	N/A	Cracks occurs on the honyecomb.
19	Heat solubility dust		N/A	Dust covers the silica gel/zeolite surface.

There is no guarantee that other substances beyond this list may reduce the dehumidification performance or damage the silica gel/zeolite.



Declaration of Conformity

1. (S) FÖRSÄKRAN OM ÖVERENSTÄMMELSE
2. (CZ) PROHLÁŠENÍ O SHODĚ
3. (DK) OPFYLDELSESERKLÆRING
4. (FI) VAKUUTUS YHDENMUKAISUUDESTA
5. (FR) DECLARATION DE CONFORMITE
6. (DE) KONFORMITÄTSERKLÄRUNG

7. (IT) DICHIARAZIONE DI CONFORMITA
8. (NL) CONFORMITEITSVERKLARING
9. (NO) SAMSVARERKLÆRING
10. (SK) VYHLÁŠENIE ZHODY
11. (DE) DECLARACION DE CONFORMIDAD
12. (GB) DECLARATION OF CONFORMITY

13. (EE) VASTAVUSDEKLARATSIOON
14. (PL) DEKLARACJA ZGODNOŚCI
15. (PT) DECLARAÇÃO DE CONFORMIDADE
16. (BG) ДЕКЛАРАЦИЯ ЗА СЪОТВЕТСТВИЕ
17. (RO) DECLARATIE DE CONFORMITATE

1. Härmed intygas att maskintypen:
2. Týmto pohlašujeme, že zařízení typu:
3. Hermed erklæres at maskintypen:
4. Täten todistamme, että kojetyyppi:
5. Confirmons par la présente que ces matériels de type :
6. Hiermit erkläre wir, dass die Maschinentypen:
7. Si conferma che l'apparecchiatura modello:
8. Bevestigd hierbij dat adsorptielucht droger type:
9. Herved erklæres at maskintypen:
10. Týmto prehlasujeme, že zariadenie typu:
11. Confirmo que las maquinas tipo:

12. Hereby confirms that machinery type:
13. Käesolevaga kinnitame, et seadmed:
14. Niniejszym potwierdza, że typ maszyny:
15. Confirma-se, pela presente, que os tipos de

16. máquina:
17. Настоящото потвърждава, че типа машини:
18. Prin prezenta confirmă tipuri de echipamente:

AQ-30/31	DR-50 (A)	R-51/61 (A/B/E)
CS-5/5L	DC-10	RL-60/60L/61/61L (A)
DC-5	DC-20	RL-71 (A/B/E)
DR-010B	DC-30 T10/T16	RL-71L (A)
DR-010B MH1/V3	DC-31 T10/T16	RZ-071/081/82/101/102/104 (A/B/C/D/E)
DR-20B/30D	DC-50 (A)	RLZ-81/82/101/102/102L/104 (A/B/C/D)
DR-31 T10	F-31	CZ-082/102/102L/104 (A/B/C/D/E)
DR-40 T10/T16	R-060BR (A)	EF/FF/RF/CF/RLF-81/82/84/101/102/104/122/152/172/192/222/242

1. är utförd i överensstämmelse med och följer följande standard(er) eller andra normgivande dokument, under förutsättning att användning sker i överensstämmelse med våra instruktioner:
2. je v souladu s následujícími standardy nebo dalšími normami a předpisy při použití podle našich pokynů:
3. er udført i overensstemmelse med og følger følgende standard (er) eller andre normgivende dokumenter, under forudsætning af at anvendelse sker i henhold til vore instruktioner:
4. on toteutettu noudattaen seuraavaa (via) standardia (oja) tai muita ohjeellisia dokumentteja, edellyttäen, että käytö tapahtuu meidän ohjeita noudattaen.
5. sont conformes à la (aux) norme(s) suivante(s) ou autre(s) document(s) normatif(s), à condition que ceux-ci soient utilisés conformément à nos instructions
6. mit den folgenden Richtlinien und Normen konform sind, wobei ein bestimmungsgemäßer Gebrauch in Übereinstimmung mit der jeweils gültigen Betriebsanleitung vorausgesetzt wird.
7. è conforme alle seguenti norme armonizzate, rispettando le nostre istruzioni d'uso:
8. in overeenstemming is met de volgende norm(en) en voorschrift(en), vooropgesteld dat deze worden toegepast/gebruikt volgens onze instructies:
9. er i samsvar med følgende standard(er) eller andre normgivende dokument(er)

- forutsatt at anvendelse skjer i henhold til våre instruksjoner:
10. je v súlade s následujícími štandardami alebo ďalšími normami a predpismi pri použití podľa našich pokynov:
11. estan en conformidad con los siguientes standards o cualquier otra normativa documental, que indique que estos se usan de acuerdo a nuestras instrucciones:
12. are in conformity with the following standard(s) or other normative document(s), provided that these are used in accordance with our instructions.
13. vastavad järgmisele(tele) standardile(tele) või normatiividele, eeldades, et kasutamine toimub vastavalt meiepoolsetele juhistele:
14. Są w zgodności z wymaganymi normami lub innymi dokumentami normatywnymi pod warunkiem, że są one wykorzystywane zgodnie z instrukcją obsługi:
15. estão em conformidade com a(s) seguinte(s) norma(s) ou outro(s) documento(s) normativo(s), desde que estas sejam utilizadas em conformidade com as nossas instruções:
16. са в съответствие със следния(ите) стандарт(и) или друг(и) нормативен(и) документ(и), при условие че те се използват в съответствие с нашите инструкции:
17. sunt în conformitate cu următorul (următoarele) standard(e) sau alt(e) document(e) normativ(e), cu condiția ca acestea să fie utilizate în conformitate cu instrucțiunile noastre:

Machinery directive (2006/42/EC)
 Electromagnetic compatibility (2014/30/EU)
 Restriction of Hazardous Substances 2 (2011/65/EC)
 Pressure equipment directive (2014/68/EU)

EN ISO 12100:2010
 EN ISO 62061-1
 EN 1886:2007
 EN 61439-1
 EN 60204-1
 EN 62491

Anders Kristoferson
 Managing Director
 Spånga

21-09-01

Date

Avestagatan 33
 S-163 53, SPÅNGA
 Sweden

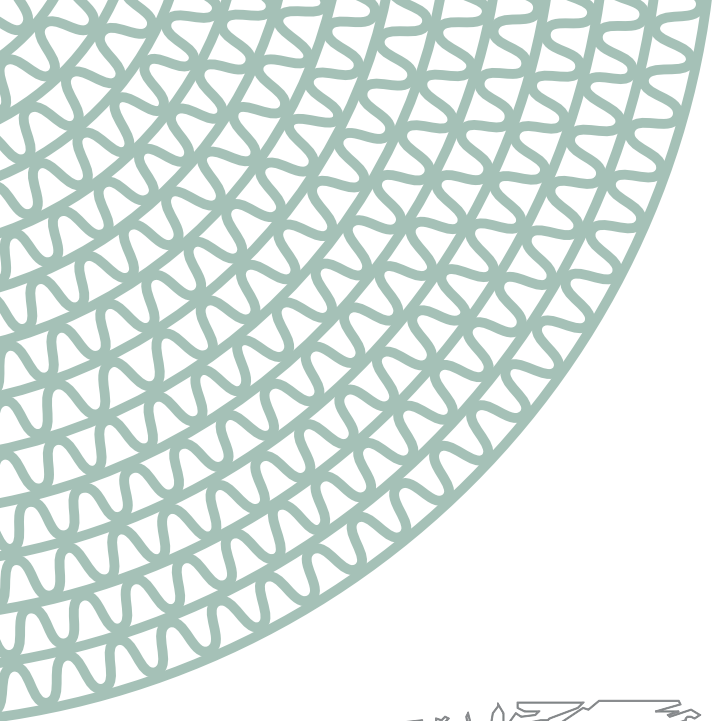

Seibu Giken DST AB
Avestagatan 33 | 163 53 Spånga, Sweden

Phone: +46 8 445 77 20 | Fax: +46 8 445 77 39
info@dst-sg.com | www.dst-sg.com



Seibu Giken DST is certified
according to ISO 9001